

Find the surface area of each composite figure. Round to the nearest tenth when necessary.

1.

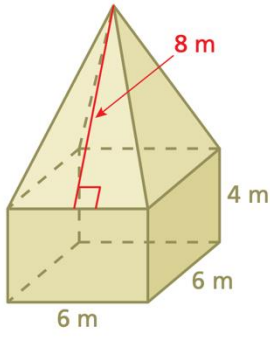

2.

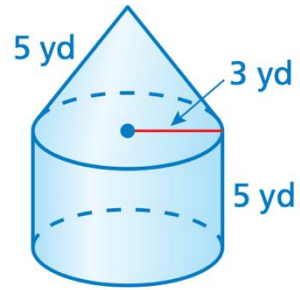

3.

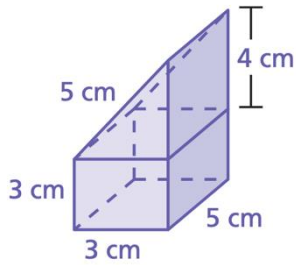

9.

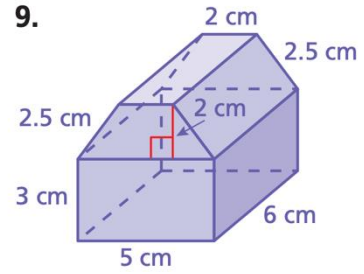

10.

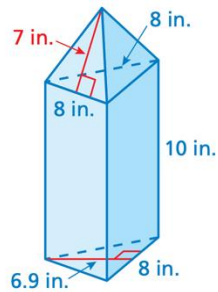

Find the volume of each composite figure. Round to the nearest tenth when necessary.

1.

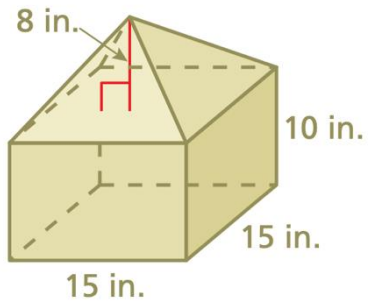

1.

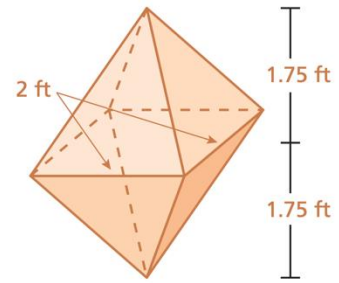

2.

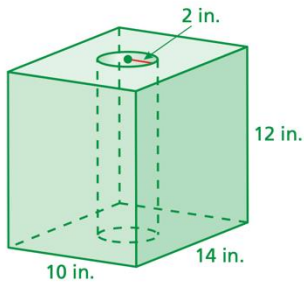

3.

